

cover

KO 125 V

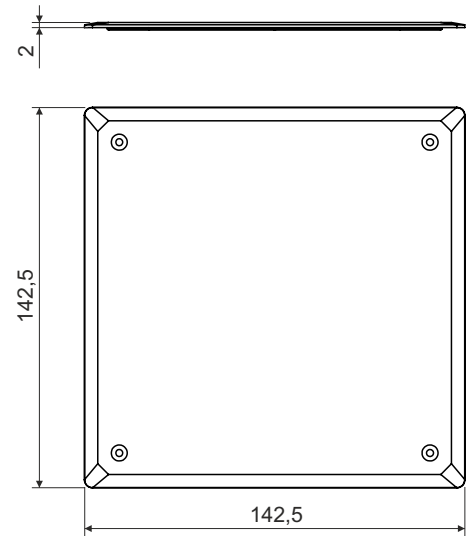

product description: to finally cover boxes KO 125

material: PVC

color: white

self-snuffing: yes, within 30 s

temperature resistance: -5 - +60 °C

flaming loop test: 850 °C

fire class for underlying material: A1-F

weight: 59 g

certification: EN 60 670-1

storage: ČSN 64 0090

configuration: HB - 10 covers packed in a foil, labeled; 130 covers packed in cardboard